

IEG1-1REC5-51F-8.00-A-01-V

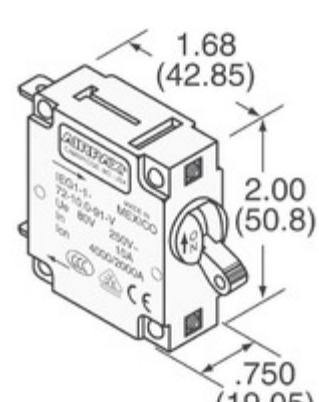

Obrázky jsou pouze orientační.
Podrobné informace o produktu naleznete v části Technické údaje produktu.

Koupit IEG1-1REC5-51F-8.00-A-01-V s důvěrou od Component-World.HK, 1 rok záruka



Part Number: [IEG1-1REC5-51F-8.00-A-01-V](#)

Výrobce: [Sensata Technologies, Airpax](#)

Popis: CIR BRKR MAG-HYDR

Datový list: [IEG,IUG,IUG,IEG,CEG,LEG Series Datasheet](#)

RoHS Status: Bez olova / V souladu RoHS

Ship From: Hong Kong

Shipment Way: DHL/Fedex/TNT/UPS/EMS

[Request For Quotation](#)









PARAMETR PRODUKTU

| | | | |
|---|--------------------------------|-----------------------------------|--|
| Part Number | IEG1-1REC5-51F-8.00-A-01-V | Výrobce | Sensata Technologies, Airpax |
| Popis | CIR BRKR MAG-HYDR | Stav volného vedení / RoHS | Bez olova / V souladu RoHS |
| Dostupné množství | 1718 pcs | Datový list | IAG,IUG,IEG,CEG,LEG Series Datasheet |
| Kategorie | Ochrana obvodu | Napítí - DC | 80V |
| Napítí - AC | 250V | Série | IEG |
| Počet pólů | 1 | Typ montáže | Panel Mount |
| Úroveň citlivosti na vlhkost (MSL) | 1 (Unlimited) | Stav volného vedení / RoHS | Lead free / RoHS Compliant |
| Osvětlení napětí (nominální) | - | Osvětlení | None |
| Jmenovitá hodnota proudu | 8A | Breaker Typ | Magnetic (Hydraulic Delay) |
| Pohon Type | Lever | | |

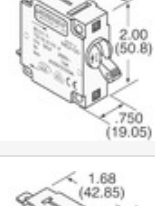
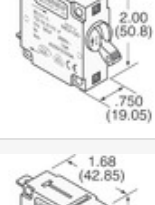
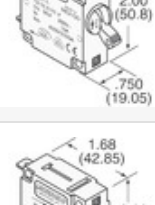
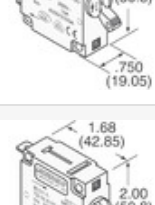
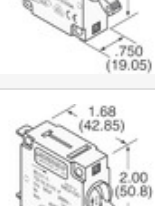
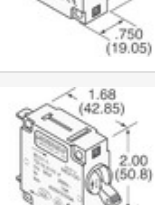
Component-World.com je spolehlivý distributor elektronických součástek. Specializujeme se na všechny elektronické komponenty řady Sensata Technologies, Airpax. Máme 1718 kusy Sensata Technologies, Airpax IEG1-1REC5-51F-8.00-A-01-V na skladě dostupných. Vyžádejte si citát z distributora součástí elektroniky na Component-World.com, náš prodejní tým vás bude kontaktovat do 24 hodin.

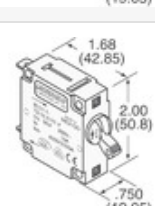
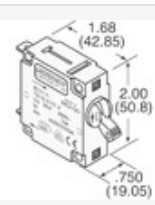
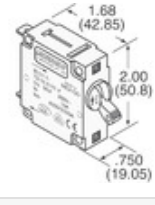
RFQ Email: info@Components-World.com

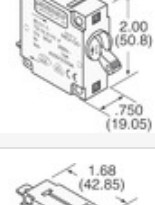
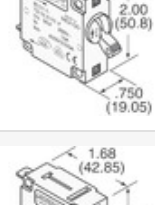
SOUVISEJÍCÍ PRODUKTY

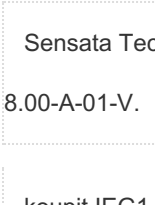
| | | | |
|--|--|--|-----------------------|
|  | Část#: IEG1-1REC4-61-5.00-01-V | Výrobci: Sensata Technologies, Airpax | Dotaz |
| | Popis: CIR BRKR MAG-HYDR LEVER 5A | | |
|  | Část#: IEG1-1REC4-62F-1.00-01-V | Výrobci: Sensata Technologies, Airpax | Dotaz |
| | Popis: CIR BRKR MAG-HYDR LEVER 1A | | |
|  | Část#: IEG1-1REC4-72-15.0-91-V | Výrobci: Sensata Technologies, Airpax | Dotaz |
| | Popis: CIR BRKR MAG-HYDR | | |
|  | Část#: IEG1-1REC5-69-100-21-V | Výrobci: Sensata Technologies, Airpax | Dotaz |
| | Popis: CIR BRKR MAG-HYDR | | |
|  | Část#: IEG1-1REG4-26371-6-V | Výrobci: Sensata Technologies, Airpax | Dotaz |
| | Popis: CIR BRKR MAG-HYDR LEVER | | |
|  | Část#: IEG1-1REC4-62-1.00-01-V | Výrobci: Sensata Technologies, Airpax | Dotaz |
| | Popis: CIR BRKR MAG-HYDR LEVER 1A | | |
|  | Část#: IEG1-1REC4-61F-5.00-01-V | Výrobci: Sensata Technologies, Airpax | Dotaz |
| | Popis: CIR BRKR MAG-HYDR LEVER 5A | | |
|  | Část#: IEG1-1REC5-69-500-31-V | Výrobci: Sensata Technologies, Airpax | Dotaz |
| | Popis: CIR BRKR MAG-HYDR | | |
|  | Část#: IEG1-1REC4-61-2.00-91-V | Výrobci: Sensata Technologies, Airpax | Dotaz |
| | Popis: CIR BRKR MAG-HYDR LEVER 2A | | |
|  | Část#: IEG1-1REC4-63-15.0-01-V | Výrobci: Sensata Technologies, Airpax | Dotaz |
| | Popis: CIR BRKR MAG-HYDR LEVER 15A | | |
|  | Část#: IEG1-1REC4-62-2.50-C-01 | Výrobci: Sensata Technologies, Airpax | Dotaz |
| | Popis: CIR BRKR MAG-HYDR | | |
|  | Část#: IEG1-1REC4-62-10.0-01-V | Výrobci: Sensata Technologies, Airpax | Dotaz |
| | Popis: CIR BRKR MAG-HYDR LEVER 10A | | |
|  | Část#: IEG1-1REC5-69-1.00-31-V | Výrobci: Sensata Technologies, Airpax | Dotaz |
| | Popis: CIR BRKR MAG-HYDR | | |
|  | Část#: IEG1-1REC5-62-250-91-V | Výrobci: Sensata Technologies, Airpax | Dotaz |
| | Popis: CIR BRKR MAG-HYDR | | |
|  | Část#: IEG1-1REC5-61-100-21-V | Výrobci: Sensata Technologies, Airpax | Dotaz |
| | Popis: CIR BRKR MAG-HYDR LEVER .1A | | |
|  | Část#: IEG1-1REG4-35887-15-V | Výrobci: Sensata Technologies, Airpax | Dotaz |
| | Popis: CIR BRKR MAG-HYDR LEVER | | |
|  | Část#: IEG1-1REC5-61-15.0-11-V | Výrobci: Sensata Technologies, Airpax | Dotaz |
| | Popis: CIR BRKR MAG-HYDR | | |
|  | Část#: IEG1-1REC5-69-500-31-UV | Výrobci: Sensata Technologies, Airpax | Dotaz |
| | Popis: CIR BRKR MAG-HYDR 500MA LEVER | | |
|  | Část#: IEG1-1REC5-62-250-91-C | Výrobci: Sensata Technologies, Airpax | Dotaz |
| | Popis: CIR BRKR MAG-HYDR LEVER .25A | | |
|  | Část#: IEG1-1REC4-61F-9.00-01-V | Výrobci: Sensata Technologies, Airpax | Dotaz |
| | Popis: CIR BRKR MAG-HYDR LEVER 9A | | |

Související klíčová slova pro IEG1-1REC5-51F-8.00-A-01-V

| | | | |
|--|--|---|-----------------------------------|
| Sensata Technologies, Airpax IEG1-1REC5-51F-8.00-A-01-V. | IEG1-1REC5-51F-8.00-A-01-V distributor | IEG1-1REC5-51F-8.00-A-01-V dodavatel | IEG1-1REC5-51F-8.00-A-01-V Cena |
| | IEG1-1REC5-51F-8.00-A-01-V Stáhnout datasheet. | IEG1-1REC5-51F-8.00-A-01-V Datasheet. | IEG1-1REC5-51F-8.00-A-01-V Stock. |
| koupit IEG1-1REC5-51F-8.00-A-01-V. | Sensata Technologies, Airpax IEG1-1REC5-51F-8.00-A-01-V. | Sensata Technologies/Airpax IEG1-1REC5-51F-8.00-A-01-V. | |